

















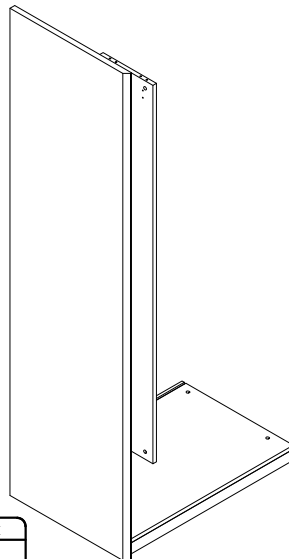
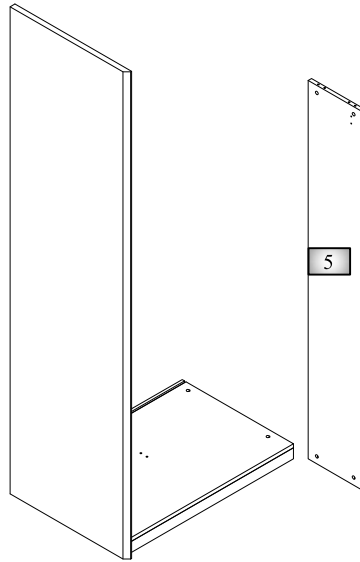
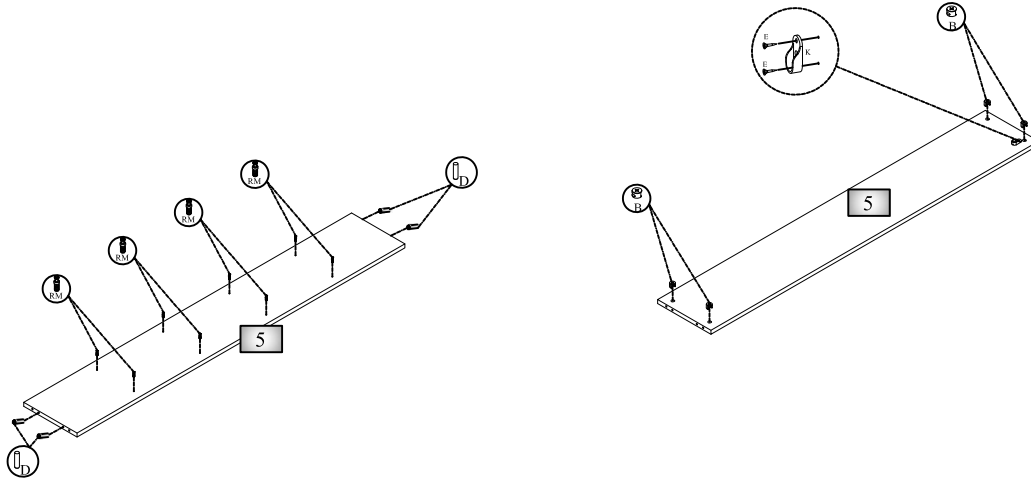



Kod Code A	Kod Code B	Kod Code C	Kod Code D	Kod Code E	Kod Code H 3	Kod Code K	Kod Code RM
FIX SCREW	FIX LOCK	FIX PLUG	Ø8mm PLS. DOWEL	3,5*18 CHIPBOARD SCREWS	SDB FLAT HINGE	HANGER FLANGE	RAMFIX M6
							

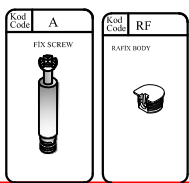
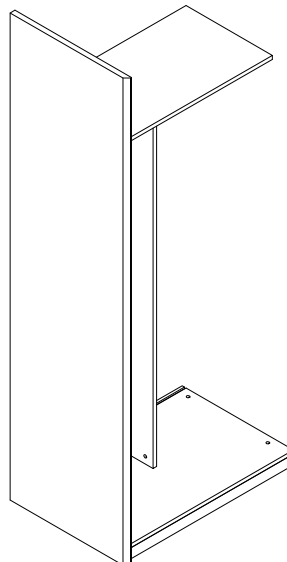
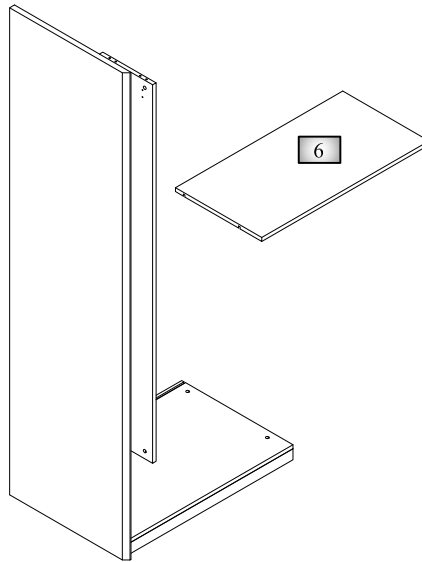
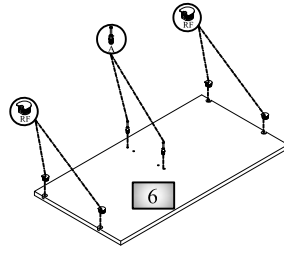
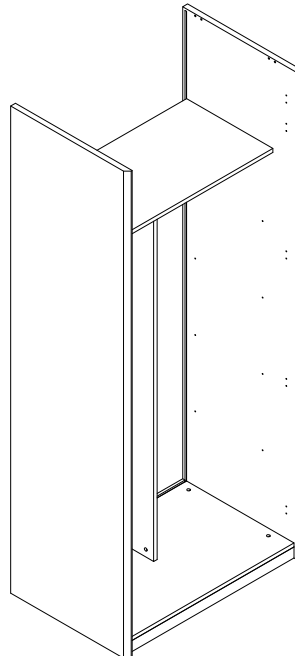
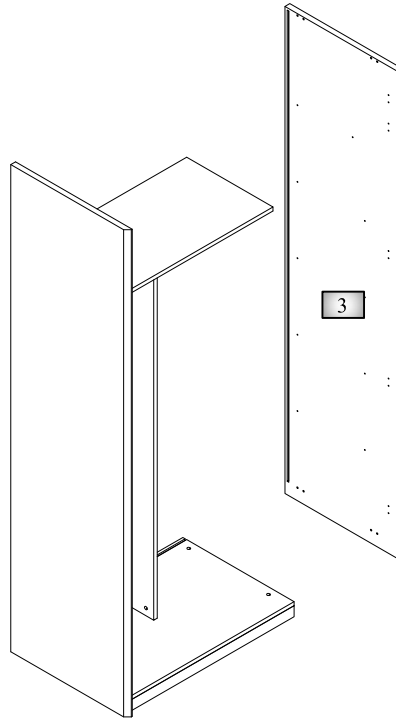
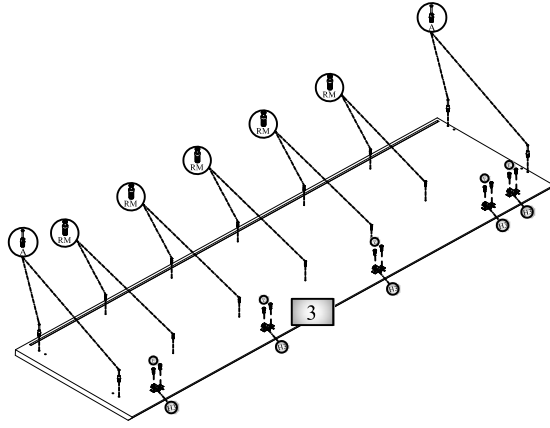

Kod Code	B	Kod Code	C	Kod Code	D	Kod Code	E	Kod Code	H 3	Kod Code	K	Kod Code	RM
	FIX LOCK		FIX PLUG		Ø8mm PLS. DOWEL		3,5*18 CHIPBOARD SCREWS		SIDE FLAT HINGE		HANGER FLANGE		RAMPEL
													





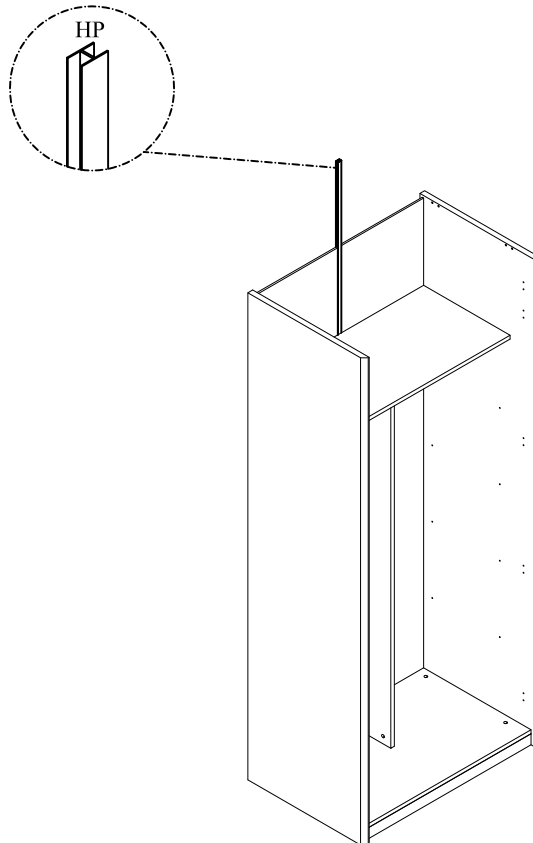
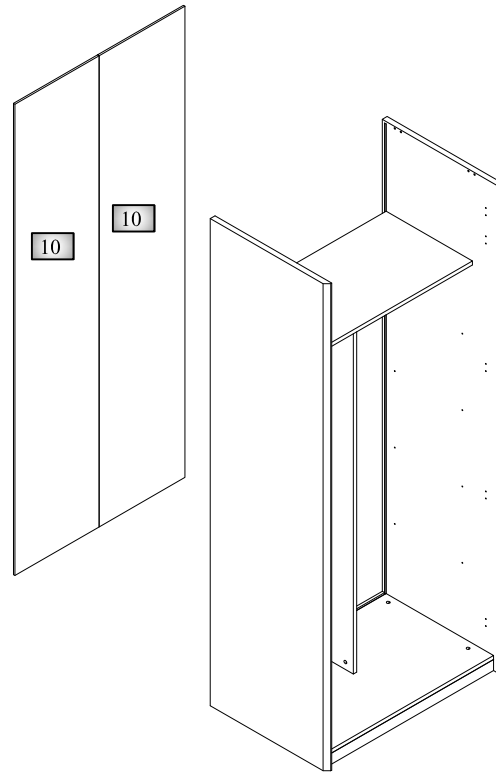

<p>Kod Code</p> <p>A</p> <p>FIX SCREW</p> 	<p>Kod Code</p> <p>RM</p> <p>RAFIX M6</p> 	<p>Kod Code</p> <p>H 3</p> <p>S500 FLAT HINGE</p> 	<p>Kod Code</p> <p>E</p> <p>3,5*18 CHIPBOARD SCREWS</p> 
--	--	--	--

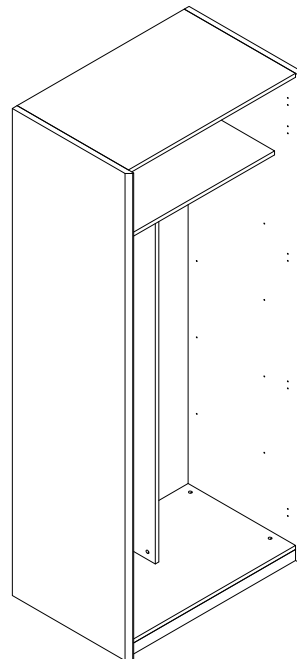
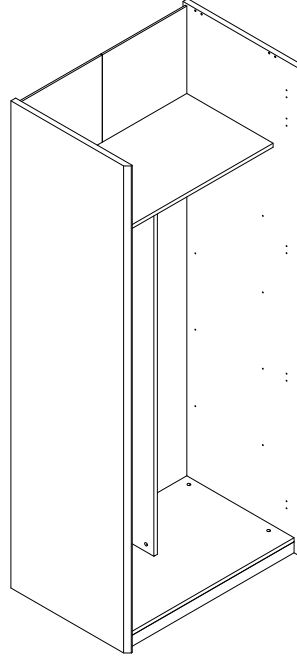
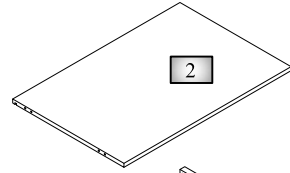
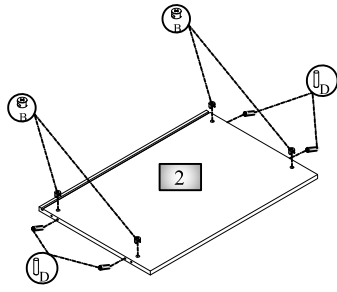



Kod Code	B	Kod Code	C	Kod Code	D
	FIX LOCK		FIX PLUG		Ø8mm PLS. DOWEL
					

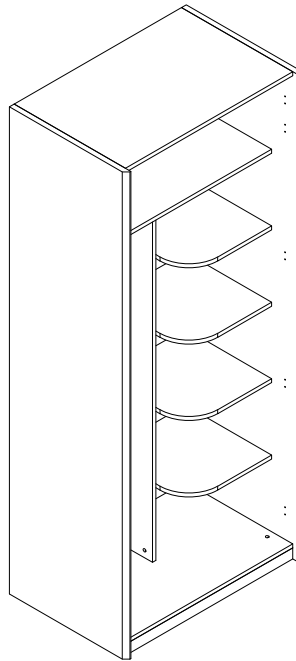
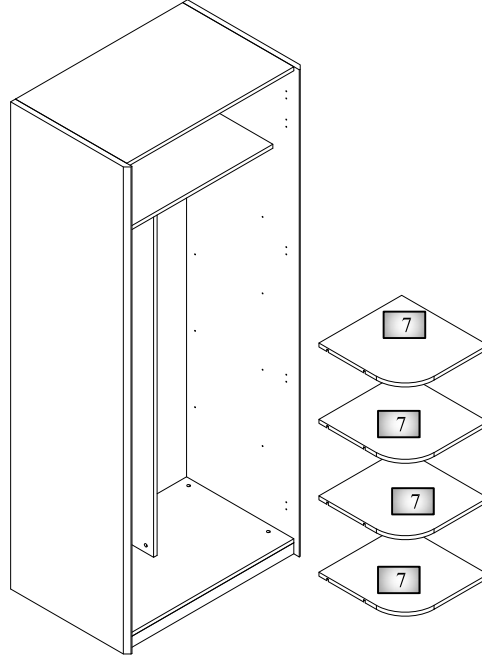
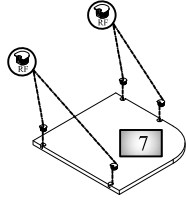

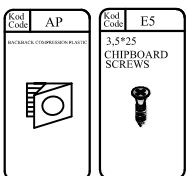
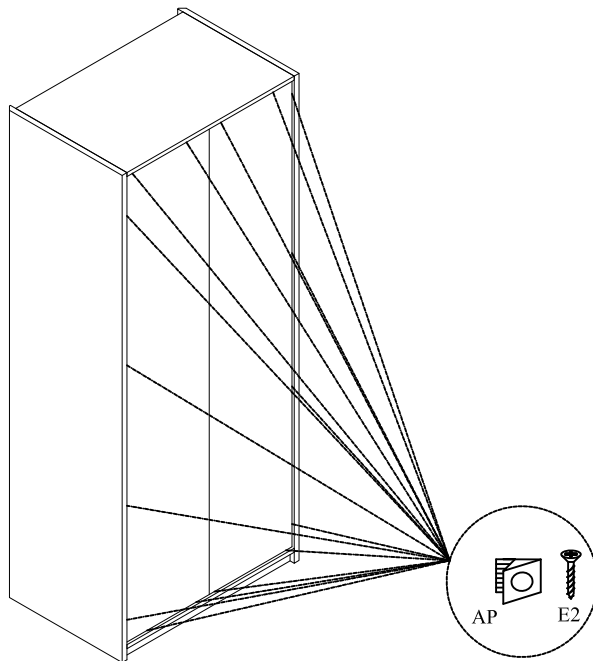
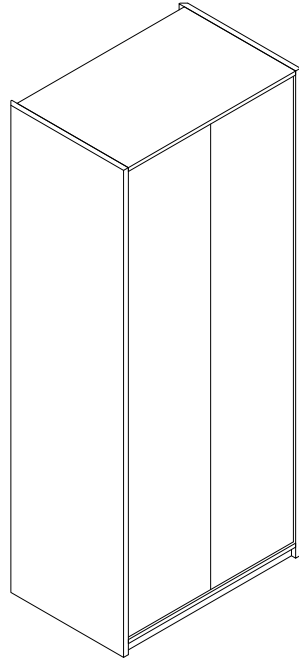

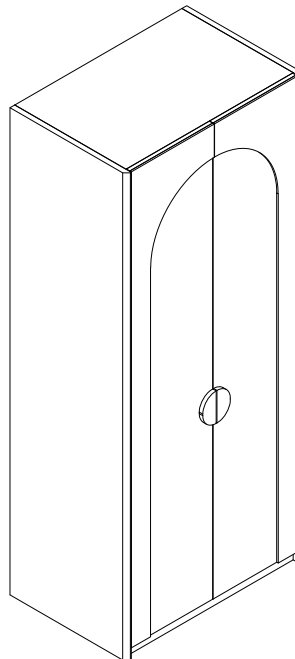
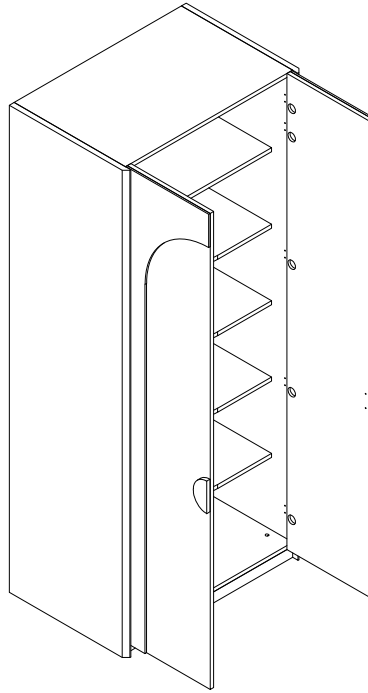
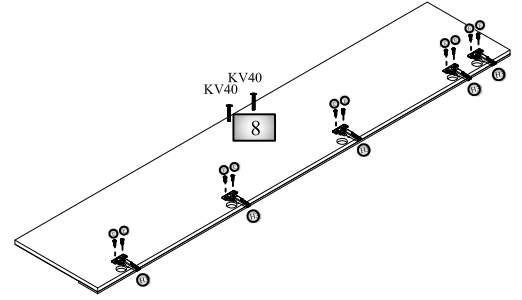
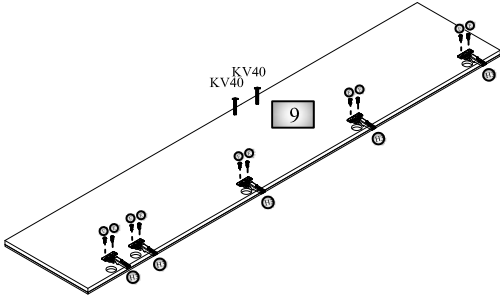

Kod Code	E	Kod Code	H 3	Kod Code	KV40	Kod Code	KLP
	3,5*18 CHIPBOARD SCREWS		SDB FLAT HINGE		6*40 SCREWS		HANDLE
	