

Sayın Müşteri,

Satın aldığınız bu ürün size ulaşmadan önce tüm ürünlerimiz Test edilmiş, kontrol edilmiş ve paketlenmiştir.

Ancak taşıma esnasında bazı parçalar zarar görebilir.

Böyle bir durumda karşılığınız ürünün tamamını geri göndermeyin.

Sadece hasarlı parçayı ve malzemeyi isteyin.

Gerekli parça ve malzemelerin kodunu kurulumda bulabilirsiniz.

Montaja başlamadan önce kutulardan çıkan ürünler eksiksiz olarak olduğundan emin olun.

Birden fazla ürün satın aldıysanız montajı tamamlamadan

ikinci ürünü açarak karışıklık yaratmayın.

Kurulumu başlamadan önce her parçayı hafif nemli bir bezle silin ve kurulumu başlatın.

Lütfen mobilyalarımızı amacı dışında kullanmayınız.

Dear Customer,

Before this product you have purchased reaches you, all of our has been tested and checked and packaged.

However, some parts may be damaged during transportation.

If you encounter such a situation, do not send the entire product back, and simply ask for the damaged part and the material.

You can find the code of the required parts and materials in the installation

Before starting the assembly, the products coming out of the boxes are complete and harmless.

make sure it is.

If you have purchased more than one product, without completing the assembly of a single product,

Do not cause confusion by opening the second product.

Before starting the installation, wipe each part with a slightly damp cloth and start the installation.

You can start.

Please do not use your furniture for other than its intended purpose.

PARÇA KODU	PARÇA ADI	ADET
1	SAG YAN TABLA	1
2	SOL YAN TABLA	1
3	ALT TABLA	1
4	ÜST TABLA	1
5	BOLME	1
6	RAF	4
7	ARKALIK	1
8	PROFİL KAPAK	1
9	KULPLU PROFİL KAPAK	1
10		
11		
12		
13		
14		
15		
16		
17		
18		
19		
20		
21		
22		
23		
24		
25		
26		
27		
28		
29		

D201 İKİ RAFLI DOLAP

KONUMLANDIRMA YAPARKEN MALZEMELERİN KODUNA VE YERİNE DİKKAT EDİLİM
LET'S PAY ATTENTION TO THE CODE AND LOCATION OF THE MATERIALS WHEN POSITIONING

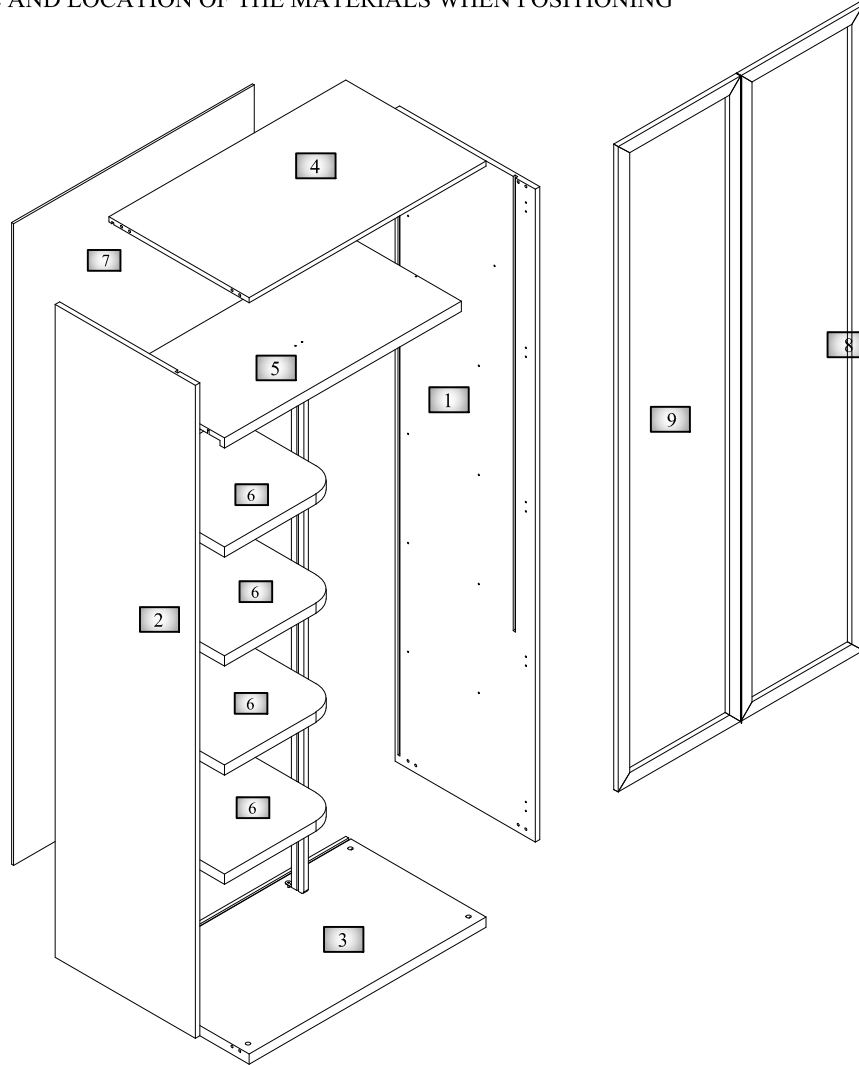

Code	Items	Qantıbes
A	FIX SCREW	8
B	FIX LOCK	8
C	FIX PLUG	8
D	ÖRMEYİ PLS. DOWEL	8
E	3,5*18 CHIPBOARD SCREWS	52
H 1	DEĞERLİNTİSİZ	6
H 2	DEĞERLİNTİSİZ FİRENGİ	4
K	HANGER FLANGE	2
RM	RAMBA VİTELİ	12
RF	RAKİT BÖCÜ	12
I	HANGER PIPE	1
E5	3,5*25 CHIPBOARD SCREWS	30
AP	4*22 SCREWS	20
KV22	4*22 SCREWS	2
DKM	METAL DİRME	1

MATERIAL
PICTURES

DETAYLI KURULAMA KODU OKUTUNUZ / READ THE DETAILED DRYING CODE

Yedek parça ihtiyacınız olması durumunda lütfen montaj talimatlarında gösterilen "Model Kodu" ve "Aksesuar Kodu"nu belirtiniz.

In case you need a sparepart, please indicate "Model Code" and "Accessory Code" shown in the assembly instructions.

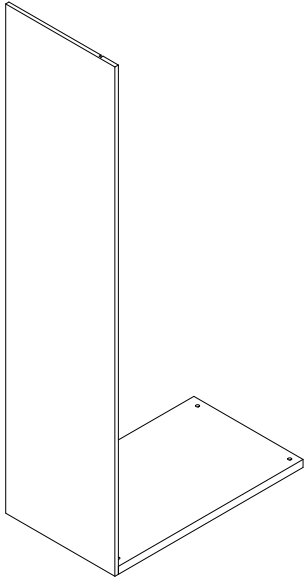
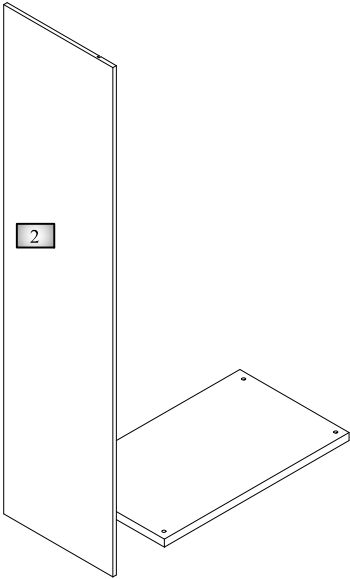
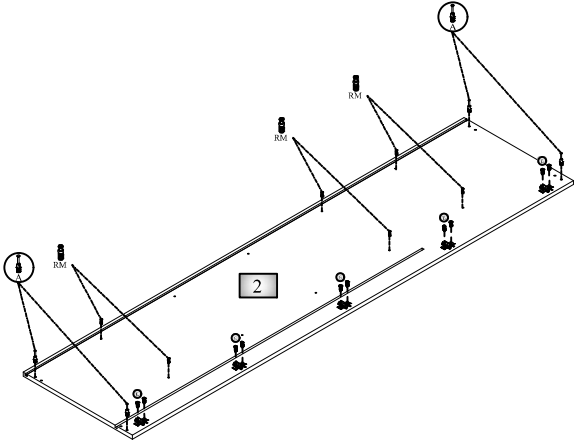
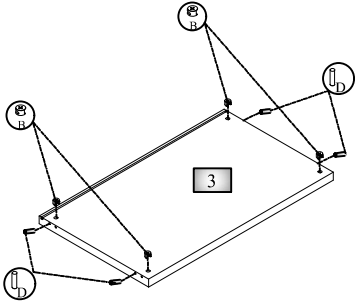

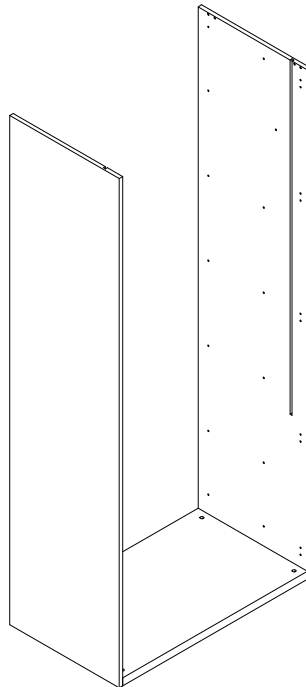
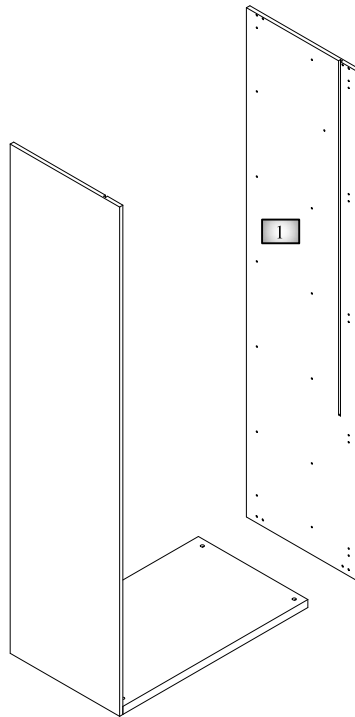
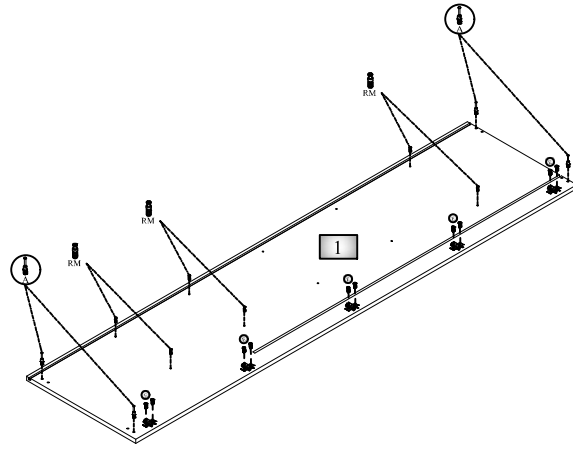

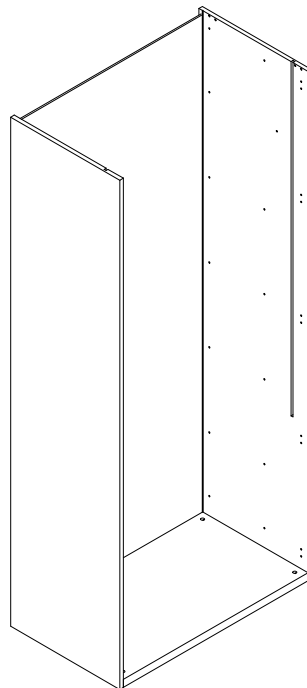
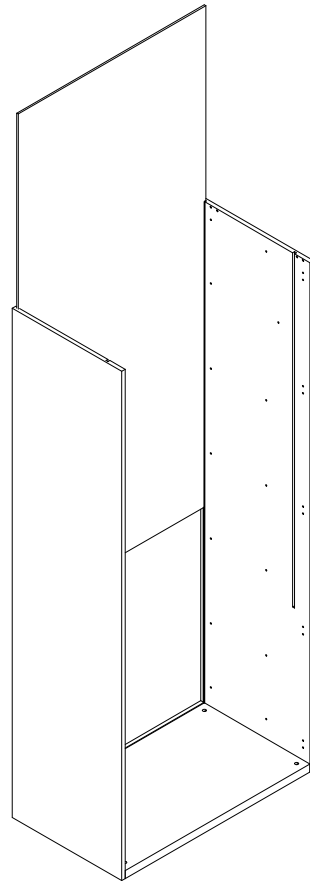

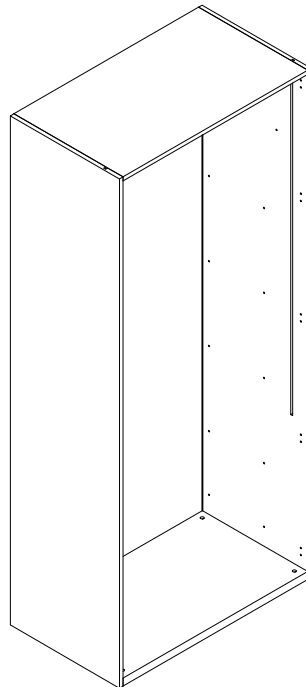
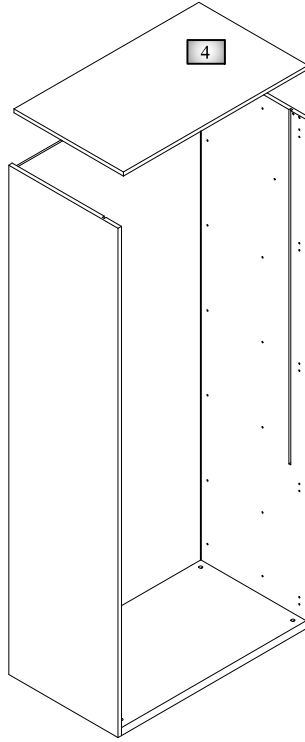
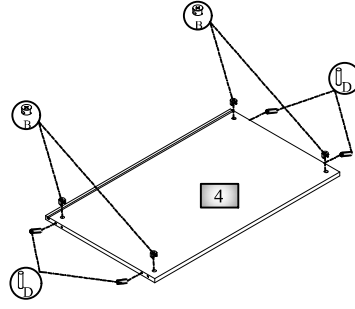

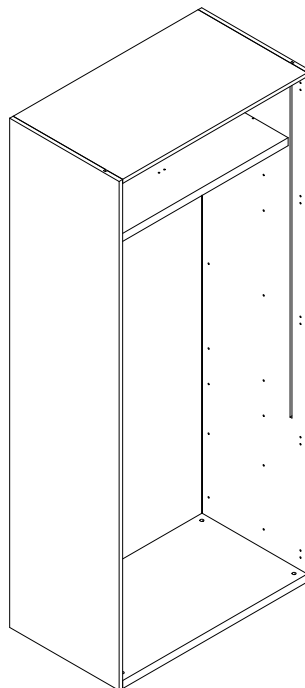
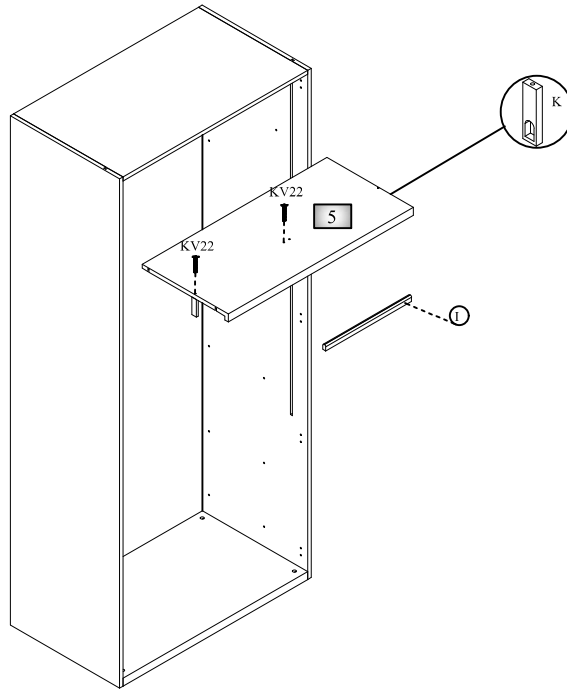
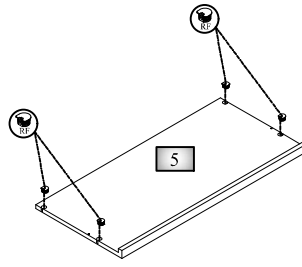

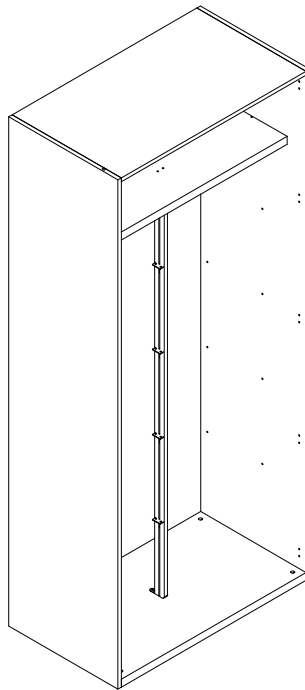
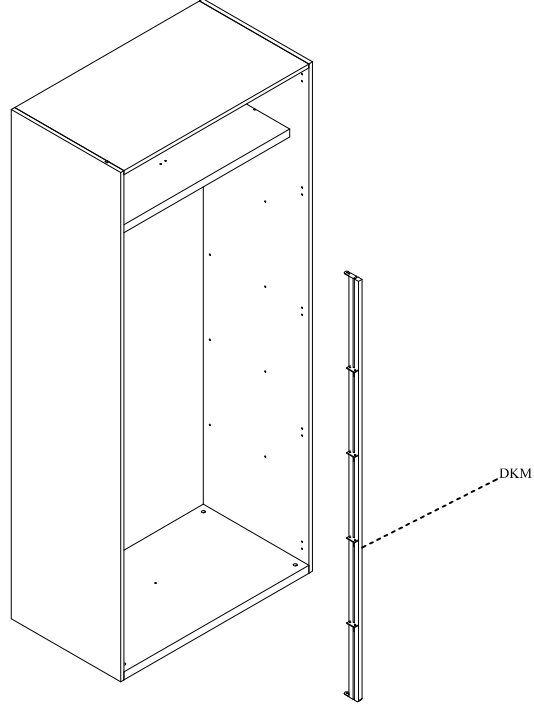

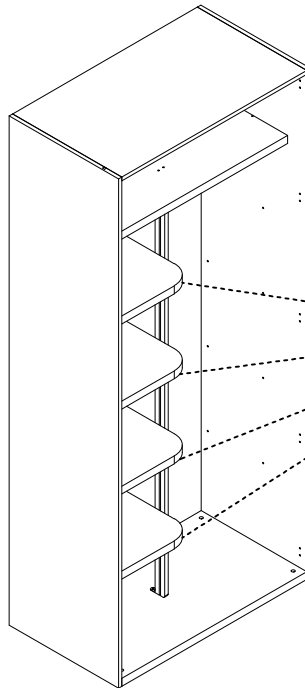
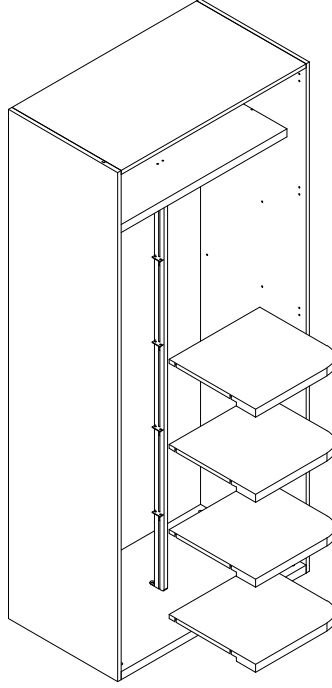
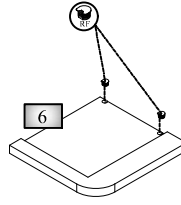

E

RAF BAĞLANTI METALLERİ RAF HIZASINE GERİLDİKTEN
SANKI RAFLAR ALTINDAN 3,5° 18 VİDA İLE SABİTLENİR

